

Taking samples / Removing sediments

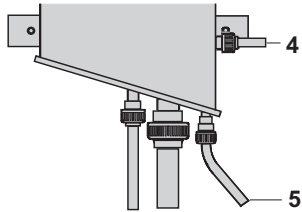

Outlet (4) serves to take samples for external analyzing (constant pressure of 300 mm water column).

If the water contains sediments, sedimentation may form on the bottom. Use outlet (5) to remove sediments.

Technical data

Dimensions (H x Ø)

495 x 340 mm
(without connecting sleeves)
735 x 340 mm (with inlet and outlet)
approx. 27 L

Volume of the vessel

Diameter of connecting sleeves

Inlet 20 mm; outlet 40 mm,
samples/sediment 16 mm

Min. flow quantity

150 - 200 L/h

Max. flow quantity

approx. 1500 L/h

Material

PVC

Max. pressure

< 1 bar



a xylem brand

Flow-Through Vessel

DMS/N

- Drawing perspective turned by 90° -

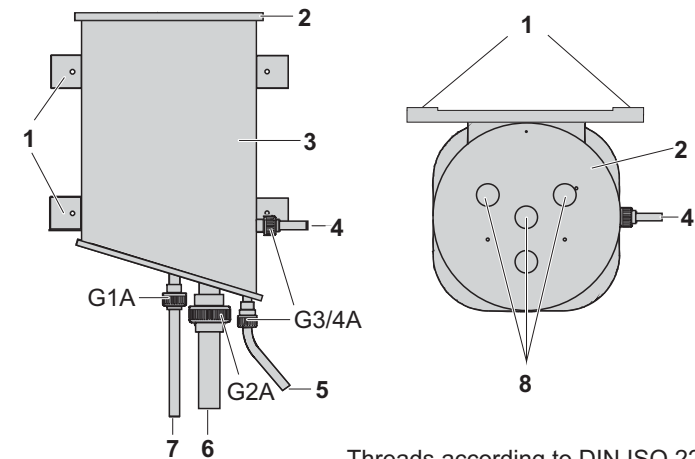

Threads according to DIN ISO 228-1

- 1 Holding device
 - 2 Lid to install 4 sensors
 - 3 Vessel
 - 4 Sample outlet (16 mm)
 - 5 Sediment outlet (16 mm*)
 - 6 Outlet (40 mm*)
 - 7 Inlet from pump (20 mm*)
 - 8 Drill-holes to install sensors
- * Outside diameter

Mounting the DMS/N

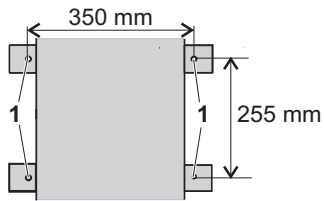

- 1 Mount the flow-through vessel at a suitable place using the supports (1). Fix the connections (4), (5), (6) and (7). To do so:

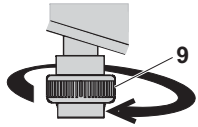

- 2 Unscrew and remove the swivel nut (9).

- 3 First pull the swivel nut (9) over the relevant flange (10), then connect the flange to the pump, outlet etc.

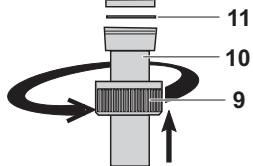

- 4 Put the O-ring (11) inside the flange and connect the flange to DMS/N. Fix it with the swivel nut (fingertight).

- 5 Close the connections (4) and (5) as long as they are not used.

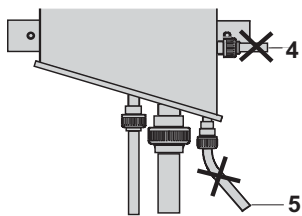

Special designs (i.e. with stop valve and check valve) are available on request.

Mounting sensors

- 6 Select the adapter from the table.

Sensor	Adapter	Order no.
TriOxmatic® 690 / 700 / 701 / 700 IN; CellOx® 700; TetraCon® 700	ADA-DF 3	203 765Y
SensoLyt® 690 / 700	ADA-DF 10	203 779Y
VisoTurb 700 IQ; ViSolid 700 IQ	ADA-DF 7	203 773Y
TetraCon® 700 IQ; SensoLyt® 700 IQ	ADA-DF 1	203 761Y
TriOxmatic 700 IQ / 700 IQ IN / 701 IQ; CellOx 700 IQ		

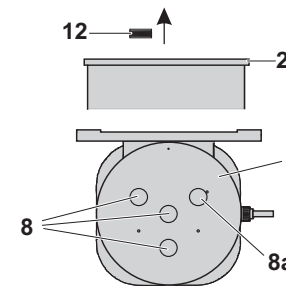

- 7 Select the mounting position and remove the cap (12) from the lid (2).



The ADA-DF 7 adapter fits in position 8a only.

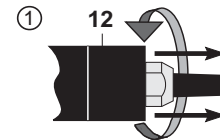

Unscrew the protection ring (12).

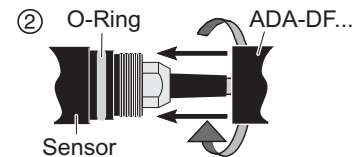

ADA-DF 1 and 7: see installation manual of the adapter.

Screw sensor into the adapter.